

FOR MESSRS : \_\_\_\_\_

DATE : Mar. 22<sup>nd</sup> ,2024

## CUSTOMER'S ACCEPTANCE SPECIFICATIONS

### TX09D202VM1CDA

#### Contents



No.	ITEM	SHEET No.	PAGE
1	COVER	7B64PS 2701-TX09D202VM1CDA-3	1-1/1
2	RECORD OF REVISION	7B64PS 2702-TX09D202VM1CDA-3	2-1/1
3	GENERAL DATA	7B64PS 2703-TX09D202VM1CDA-3	3-1/1
4	ABSOLUTE MAXIMUM RATINGS	7B64PS 2704-TX09D202VM1CDA-3	4-1/1
5	ELECTRICAL CHARACTERISTICS	7B64PS 2705-TX09D202VM1CDA-3	5-1/1
6	OPTICAL CHARACTERISTICS	7B64PS 2706-TX09D202VM1CDA-3	6-1/2~2/2
7	BLOCK DIAGRAM	7B64PS 2707-TX09D202VM1CDA-3	7-1/1
8	RELIABILITY TESTS	7B64PS 2708-TX09D202VM1CDA-3	8-1/1
9	LCD INTERFACE	7B64PS 2709-TX09D202VM1CDA-3	9-1/7~7/7
10	OUTLINE DIMENSIONS	7B64PS 2710-TX09D202VM1CDA-3	10-1/1
11	APPEARANCE STANDARD	7B64PS 2711-TX09D202VM1CDA-3	11-1/3~3/3
12	PRECAUTIONS	7B64PS 2712-TX09D202VM1CDA-3	12-1/2~2/2
13	DESIGNATION OF LOT MARK	7B64PS 2713-TX09D202VM1CDA-3	13-1/1

ACCEPTED BY : \_\_\_\_\_

PROPOSED BY: Max Lee

JDI Taiwan Inc. Kaohsiung Branch	SHEET NO.	7B64PS 2701-TX09D202VM1CDA-3	PAGE	1-1/1
----------------------------------	-----------	------------------------------	------	-------

## 2. RECORD OF REVISION

DATE	SHEET No.	SUMMARY												
Mar.01,'23	7B64PS 2701 – TX09D202VM1CDA-2 Page 1-1/1	Company logo changed :  → 												
	7B64PS 2709- TX09D202VM1CDA-2 Page 9-1/5													
	All page													
Mar.22,'24	7B64PS 2703 – TX09D202VM1CDA-3 Page 3 – 1/1	3.1 DISPLAY FEATURES Revision Module Dimensions: 6.7(D)→7.3(D)												
	7B64PS 2709- TX09D202VM1CDA-3 Page 9-1/7	9.1 INTERFACE PIN CONNECTIONS Connector (CN1) changed FA5S040HP1R3000 made by JAE(Thickness: 0.3±0.05mm) ↓ 60025-4007-5001 made by TOPWISE (FPC: Thickness: 0.3±0.05mm)												
	7B64PS 2710- TX09D202VM1CDA-3 Page 10-1/1	10. OUTLINE DIMENSIONS The max of total thickness changed:7.0mm→7.6mm												
	7B64PS 2713- TX09D202VM1CDA-3 Page 13-1/1	13. DESIGNATION of LOT MARK Added :												
		<table border="1"> <thead> <tr> <th>REV.No</th> <th>ITEM</th> <th>REMARKS</th> </tr> </thead> <tbody> <tr> <td>A</td> <td>-</td> <td>-</td> </tr> <tr> <td>B</td> <td>Color filter changed</td> <td>PCN 1028</td> </tr> <tr> <td>B</td> <td>Connector (CN1) changed</td> <td>PCN 1097</td> </tr> </tbody> </table>	REV.No	ITEM	REMARKS	A	-	-	B	Color filter changed	PCN 1028	B	Connector (CN1) changed	PCN 1097
REV.No	ITEM	REMARKS												
A	-	-												
B	Color filter changed	PCN 1028												
B	Connector (CN1) changed	PCN 1097												

### 3. GENERAL DATA

#### 3.1 DISPLAY FEATURES

This module is a 3.5" QVGA of 3:4 format amorphous silicon TFT. The pixel format is vertical stripe and sub pixels are arranged as R(red), G(green), B(blue) sequentially. This display is RoHS compliant, and COG (chip on glass) technology and LED backlight are applied on this display.

Part Name	TX09D202VM1CDA
Module Dimensions	64.0(W) mm x 86.0(H) mm x 7.3(D) mm
LCD Active Area	53.64(W) mm x 71.52(H) mm
Pixel Pitch	0.2235(W) mm x 0.2235(H) mm
Resolution	240 x 3(RGB)(W) x 320(H) dots
Color Pixel Arrangement	R, G, B Vertical stripe
LCD Type	Transmissive Color TFT; Normally White
Display Type	Active Matrix
Number of Colors	262k Colors (6-bit RGB)
Backlight	Light Emitting Diode (LED)
Weight	36g
Interface	C-MOS; 40 pins
Power Supply Voltage	3.3V (Including LCD ,Timing Controller and Backlight)
Power Consumption	0.42 W
Viewing Direction	6 O'clock (without image inversion and least brightness change) 12 O'clock (contrast peak located at)

## 4. ABSOLUTE MAXIMUM RATINGS

Item		Symbol	Min.	Max.	Unit	Remarks
Supply Voltage		$V_{DD}$	-0.3	4.0	V	-
Input Voltage of Logic		$V_I$	-0.3	$V_{DD}+0.3$	V	Note 1
Operating Temperature		$T_{op}$	-20	70	°C	Note 2
Storage Temperature		$T_{st}$	-30	80	°C	Note 2
LED Backlight	Forward Current	$I_F$	-	30	mA	Note 3
	Pulse Forward Current	$I_{FP}$	-	100	mA	Note 4
	Reverse Voltage	$V_R$	-	5	V	LED unit

Note 1: The rating is defined for the signal voltages of the interface such as DTMG, DCLK and RGB data bus.

Note 2: The maximum rating is defined as above based on the chamber temperature, which might be different from ambient temperature after assembling the panel into the application. Moreover, some temperature-related phenomenon as below needed to be noticed:

- Background color, contrast and response time would be different from 25°C.
- Operating under high temperature will shorten LED lifetime.

Note 3: Fig. 4.1 shows the maximum rating of forward current based on different temperature for LED unit.

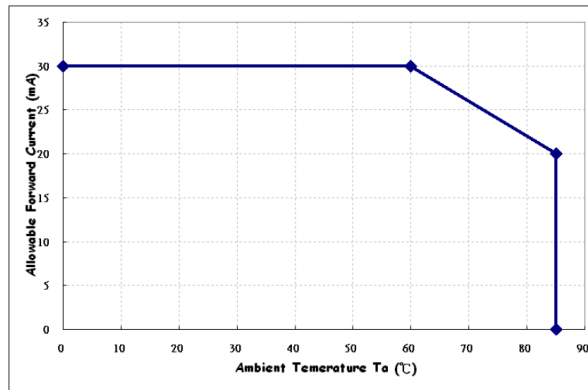

Fig. 4.1

Note 4: Fig. 4.2 shows the LED characteristics of the relationship between  $I_{FP}$  vs. duty ratio, which is related to dimming control of LED backlight.

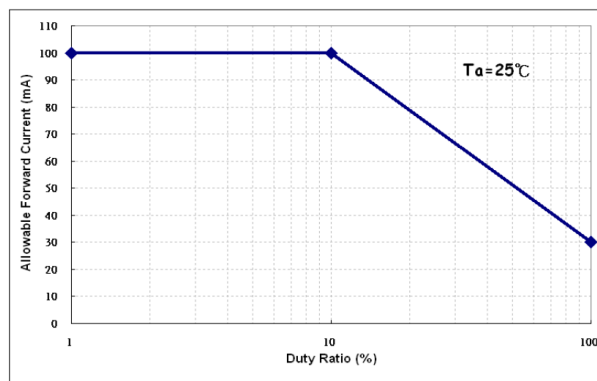

Fig. 4.2

# 5. ELECTRICAL CHARACTERISTICS

## 5.1 LCD CHARACTERISTICS

$T_a = 25\text{ }^\circ\text{C}$ ,  $V_{SS} = 0\text{V}$

Item	Symbol	Condition	Min.	Typ.	Max.	Unit	Remarks
Power Supply Voltage	$V_{DD}$	-	3.0	3.3	3.6	V	-
Input Voltage of Logic	$V_I$	"H" level	$0.8 V_{DD}$	-	$V_{DD}$	V	Note 1
		"L" level	$V_{SS}$	-	$0.2 V_{DD}$		
Power Supply Current	$I_{DD}$	$V_{DD}-V_{SS}=3.0\text{V}$	-	125	150	mA	Note 2,3
Frame Frequency	$f_{Frame}$	-	50	60	68	Hz	-
DCLK Frequency	$f_{CLK}$	-	4.75	5.7	6.5	MHz	

Note 1: The rating is defined for the signal voltages of the interface such as DTMG, DCLK and RGB data bus.

Note 2: An all black check pattern is used when measuring  $I_{DD}$ .  $f_{Frame}$  is set to 60Hz.

Note 3: 0.4A fuse is applied in the module for  $I_{DD}$ . For display activation and protection purpose, power supply is recommended larger than 1.0A to start the display and break fuse once any short circuit occurred.

## 5.2 BACKLIGHT CHARACTERISTICS

$T_a = 25\text{ }^\circ\text{C}$

Item	Symbol	Condition	Min.	Typ.	Max.	Unit	Remarks
LED Input Voltage	$V_F$	$I_F=15.4\text{mA}$	3.0	3.3	3.6	V	LED/Part
LED Forward Current	$I_F$	-	-	15.4	25	mA	LED/Part
LED Reverse Current	$I_R$	$V_R=5\text{V}$	-	-	10	$\mu\text{A}$	LED/Part
LED Current Control	$V_{ctrl}$	$V_{DD}-V_{SS}=3.3\text{V}$	0	1.8	4.0	V	Note 1,2

Note 1: As Fig. 5.1 shown, LED current is controlled by the LED driver when applying 3.3V.

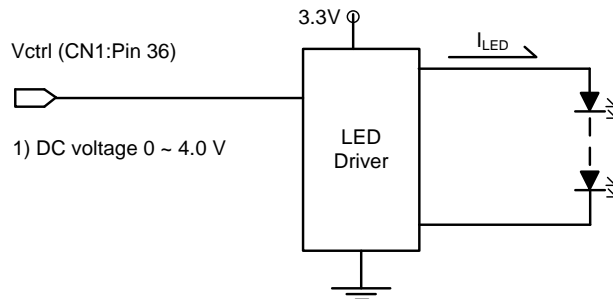
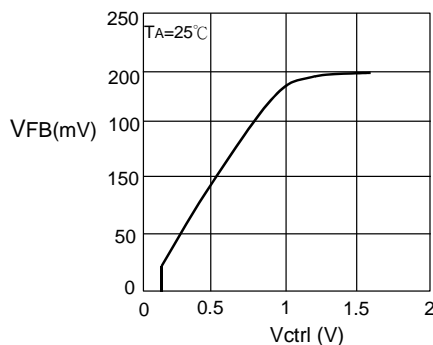

Fig 5.1

Note 2: LED current depend on following conditions.

LED current is calculated by  $V_{ctrl}$  and  $V_{FB}$  when  $V_{FB}$  is controlled by  $V_{ctrl}$ .



$$I_{LED} : \frac{V_{FB}}{10} : \text{When } V_{ctrl} > 1.8 \text{ V}$$

$$I_{LED} : \frac{V_{ctrl}}{50} : \text{When } V_{ctrl} < 1 \text{ V.}$$

## 6. OPTICAL CHARACTERISTICS

The optical characteristics are measured based on the conditions as below:

- Supplying the signals and voltages defined in the section of electrical characteristics.
- The backlight unit needs to be turned on after 30 minutes.
- The ambient temperature is 25 °C .
- In the dark room less than 100 lx, the equipment has been set for the measurements as shown in Fig 6.1.

$$T_a = 25\text{ }^\circ\text{C}, f_{Frame} = 60\text{ Hz}, V_{DD} = 3.3\text{V}$$

Item	Symbol	Condition	Min.	Typ.	Max.	Unit	Remarks	
Brightness of White	B	$\phi = 0^\circ, \theta = 0^\circ$ 15.4 mA/per LED	320	400	-	cd/m <sup>2</sup>	Note 1	
Brightness Uniformity	-		70	-	-	%	Note 2	
Contrast Ratio	CR		180	300	-	-	Note 3	
Response Time	Tr+Tf	$\phi = 0^\circ, \theta = 0$	-	30	-	ms	Note 4	
Viewing Angle	$\theta = X$	$\phi = 0^\circ, CR \geq 10$	-	70	-	Degree	Note 5	
	$\theta = X'$	$\phi = 180^\circ, CR \geq 10$	-	70	-			
	$\theta = Y$	$\phi = 90^\circ, CR \geq 10$	-	80	-			
	$\theta = Y'$	$\phi = 270^\circ, CR \geq 10$	-	60	-			
Color Chromaticity	Red	X	$\phi = 0^\circ, \theta = 0$	0.54	0.59	0.64	-	Note 6
		Y		0.29	0.34	0.39		
	Green	X		0.31	0.36	0.41		
		Y		0.51	0.56	0.61		
	Blue	X		0.10	0.15	0.20		
		Y		0.08	0.13	0.18		
	White	X		0.28	0.33	0.38		
		Y		0.29	0.34	0.39		

Note 1: The brightness is measured from the center point of the panel, P5 in Fig. 6.2, for the typical value.

Note 2: The brightness uniformity is calculated by the equation as below:

$$\text{Brightness uniformity} = \frac{\text{Min. Brightness}}{\text{Max. Brightness}} \times 100\%$$

which is based on the brightness values of the 9 points measured by BM-5 as shown in Fig. 6.2.

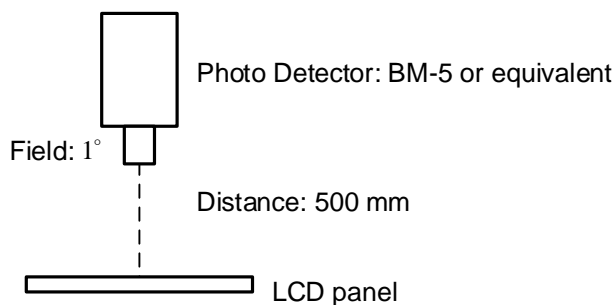

Fig. 6.1

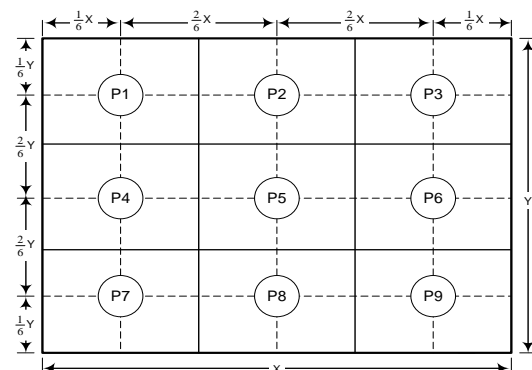

Fig. 6.2

Note 3: The contrast ratio is measured from the center point of the panel, P5, and defined as the following equation:

$$CR = \frac{\text{Brightness of White}}{\text{Brightness of Black}}$$

Note 4: The definition of response time is shown in Fig. 6.3. Rising time is the period from 90% brightness down to 10% brightness when the data is from white turning to black. Oppositely, Falling time is the period from 10% brightness rising to 90% brightness.

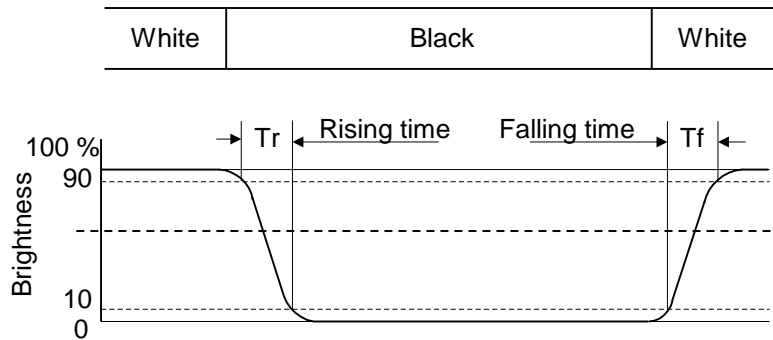

Fig. 6.3

Note 5: The definition of viewing angle is shown in Fig. 6.4. Angle  $\phi$  is used to represent viewing directions, for instance,  $\phi=270^\circ$  means 6 o'clock, and  $\phi=0^\circ$  means 3 o'clock. Moreover, angle  $\theta$  is used to represent viewing angles from axis Z toward plane XY.

The viewing direction of this display is 6 o'clock, which means that a photograph with gray scale would not be reversed in color and the brightness change would be less from this direction. However, the contrast peak would be located at 12 o'clock.

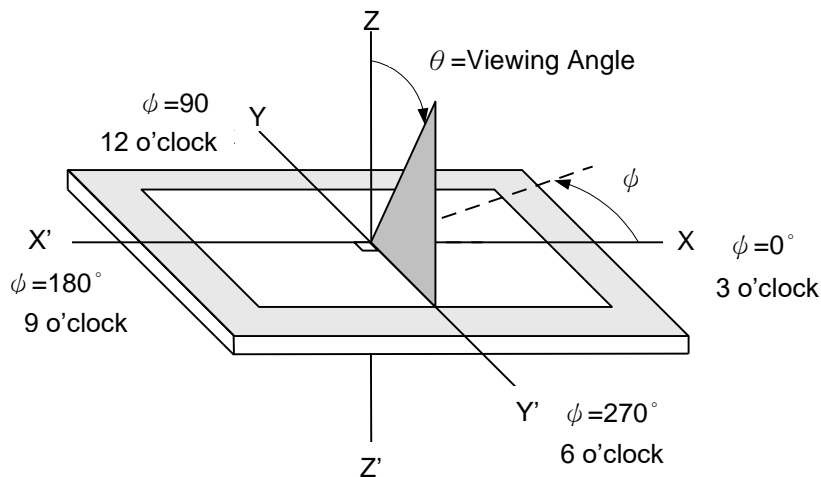
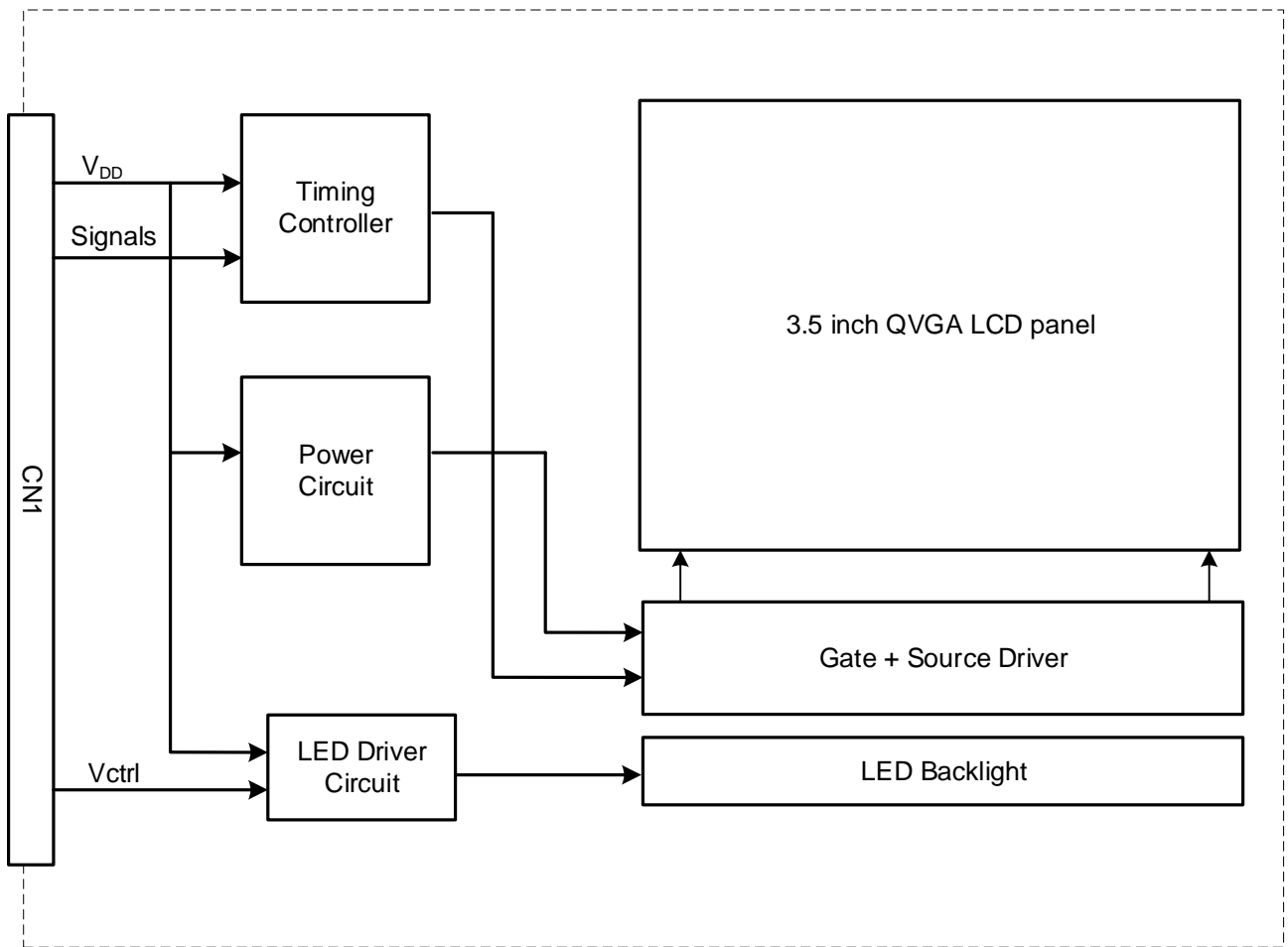

Fig. 6.4

Note 6: The color chromaticity is measured from the center point of the panel, P5, as shown in Fig. 6.2.

## 7. BLOCK DIAGRAM



Note 1: Signals are DTMG, DCLK and RGB data bus.



## 8. RELIABILITY TESTS

Test Item	Condition	
High Temperature	1) Operating 2) 70 °C	240 hrs
Low Temperature	1) Operating 2) -20 °C	240 hrs
High Temperature	1) Storage 2) 80 °C	240 hrs
Low Temperature	1) Storage 2) -30 °C	240 hrs
Heat Cycle	1) Operating 2) -20 °C ~70 °C 3) 3hrs~1hr~3hrs	240 hrs
Thermal Shock	1) Non-Operating 2) -35 °C ↔ 85 °C 3) 0.5 hr ↔ 0.5 hr	240 hrs
High Temperature & Humidity	1) Operating 2) 40 °C & 85%RH 3) Without condensation	240 hrs (Note 3)
Vibration	1) Non-Operating 2) 20~200 Hz 3) 2G 4) X, Y, and Z directions	1 hr for each direction
Mechanical Shock	1) Non-Operating 2) 10 ms 3) 50G 4) ±X, ±Y and ±Z directions	Once for each direction
ESD	1) Operating 2) Tip: 150 pF, 330 Ω 3) Air discharge for glass: ± 8KV 4) Contact discharge for metal frame: ± 8KV	1) Glass: 9 points 2) Metal frame: 8 points (Note4)

Note 1: Display functionalities are inspected under the conditions defined in the specification after the reliability tests.

Note 2: The display is not guaranteed for use in corrosive gas environments.

Note 3: Under the condition of high temperature & humidity, if the temperature is higher than 40 °C, the humidity needs to be reduced as Fig. 8.1 shown.

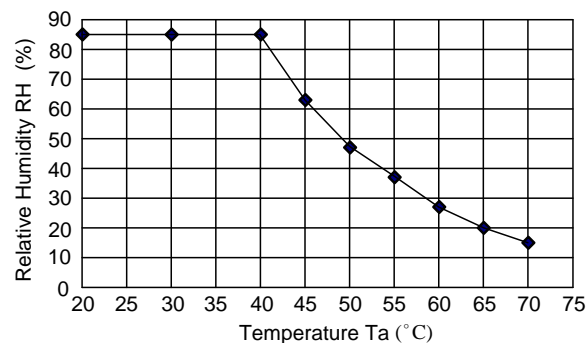

Fig. 8.1

Note 4: All pins of LCD interface(CN1) have been tested by ± 100V contact discharge of ESD under non-operating condition.

## 9. LCD INTERFACE

### 9.1 INTERFACE PIN CONNECTIONS

The connector of display interface is 60025-4007-5001 made by TOPWISE (FPC: Thickness:  $0.3 \pm 0.05\text{mm}$ ; Pitch:  $0.5 \pm 0.05\text{mm}$ ) and more details of the connector are shown in the section of outline dimension.

Pin assignment of LCD interface is as below:

Pin No.	Signal	Function	Pin No.	Signal	Function
1	V <sub>DD</sub>	Power Supply for Logic	21	G4	Green Data
2	V <sub>DD</sub>		22	G3	
3	V <sub>DD</sub>		23	V <sub>SS</sub>	GND
4	DCLK	Dot Clock	24	G2	Green Data
5	V <sub>SS</sub>	GND	25	G1	
6	HSYNC	Horizontal Sync Pulse	26	G0	
7	V <sub>SS</sub>	GND	27	V <sub>SS</sub>	GND
8	DTMG	Timing Signal for Data	28	B5	Blue Data
9	V <sub>SS</sub>	GND	29	B4	
10	NC	No Connection	30	B3	
11	V <sub>SS</sub>	GND	31	V <sub>SS</sub>	GND
12	R5	Red Data	32	B2	Blue Data
13	R4		33	B1	
14	R3		34	B0	
15	V <sub>SS</sub>	GND	35	PCI	Power Control In (Note 1)
16	R2	Red Data	36	V <sub>ctrl</sub>	LED Current Control
17	R1		37	NC	No Connection
18	R0		38	NC	No Connection
19	V <sub>SS</sub>	GND	39	NC	No Connection
20	G5	Green Data	40	NC	No Connection

Note 1: Please follow the page 8-5/7 to set the PCI.

## 9.2 TIMING CHART

### SYNCHRONOUS MODE

#### Horizontal

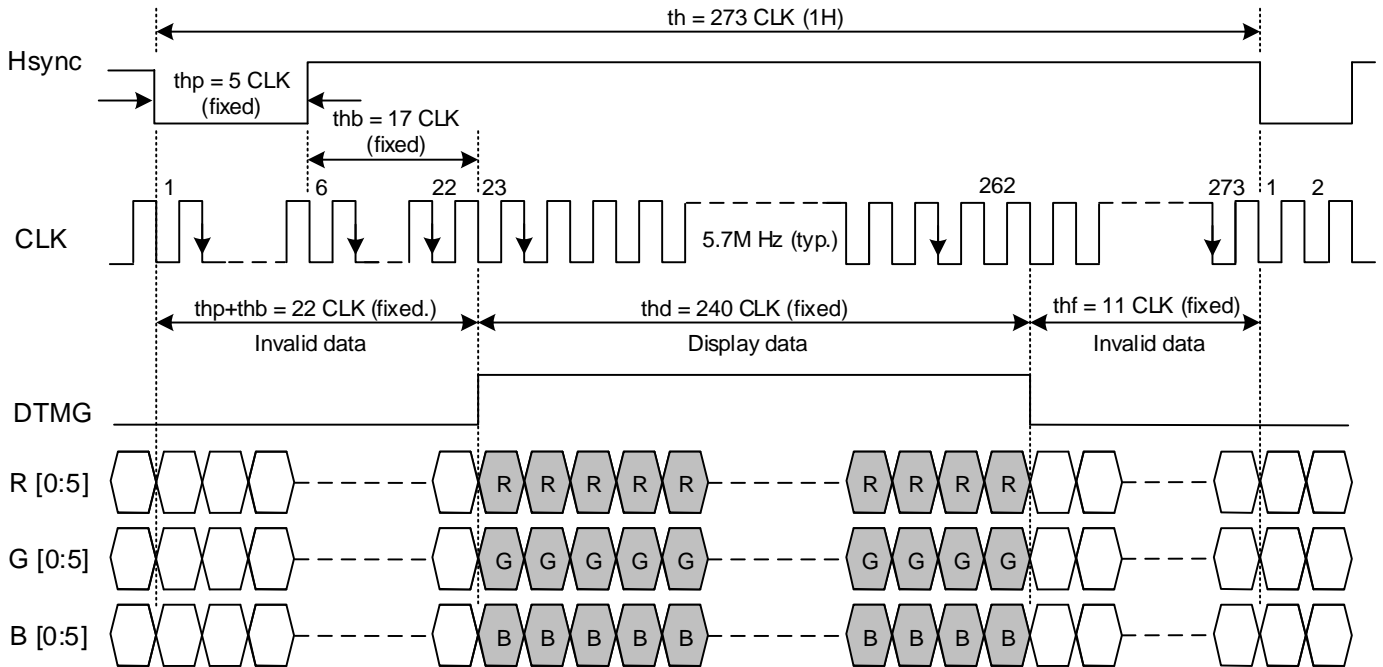

#### Vertical

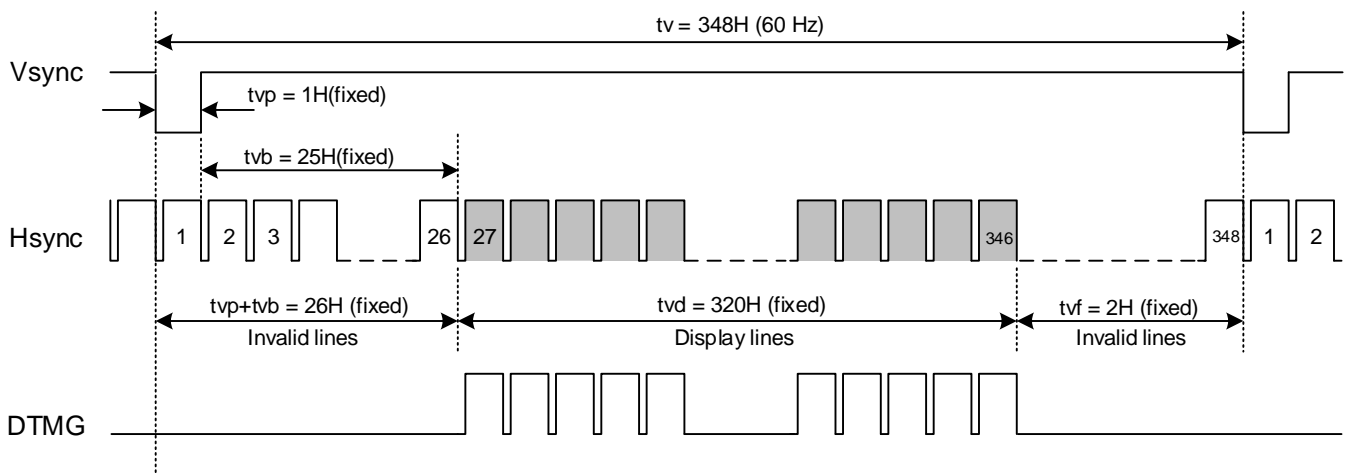

Note 1: Data is latched negative edge trigger of DCLK.

Note 2: VSYNC is generated by internally.

Note 3: DTMG should be low during the blanking time.

B. CLOCK AND DATA INPUT TIMING

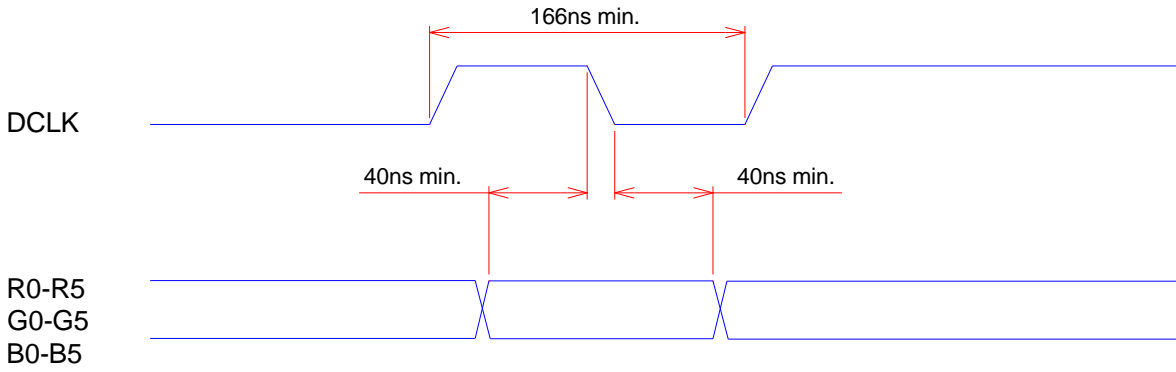

Setup & Hold Time

### 9.3 INTERFACE TIMING SPECIFICATIONS

#### SYNCHRONOUS MODE

	Item	Symbol	Value	Unit
Hsync	CLK Frequency	fclk	5.7	MHz
	Display Data	thd	240	DCLK
	Cycle Time	th	273	
	Pulse Width	thp	5	
	Pulse Width and Back Porch	thp + thb	22	
	Front Porch	thf	11	
Vsync	Display Line	tvd	320	Hsync
	Cycle Time	tv	348	
	Pulse Width	tvp	1	
	Pulse Width and Back Porch	tvp + tvb	26	
	Front Porch	tvf	2	

## 9.4 POWER SEQUENCE

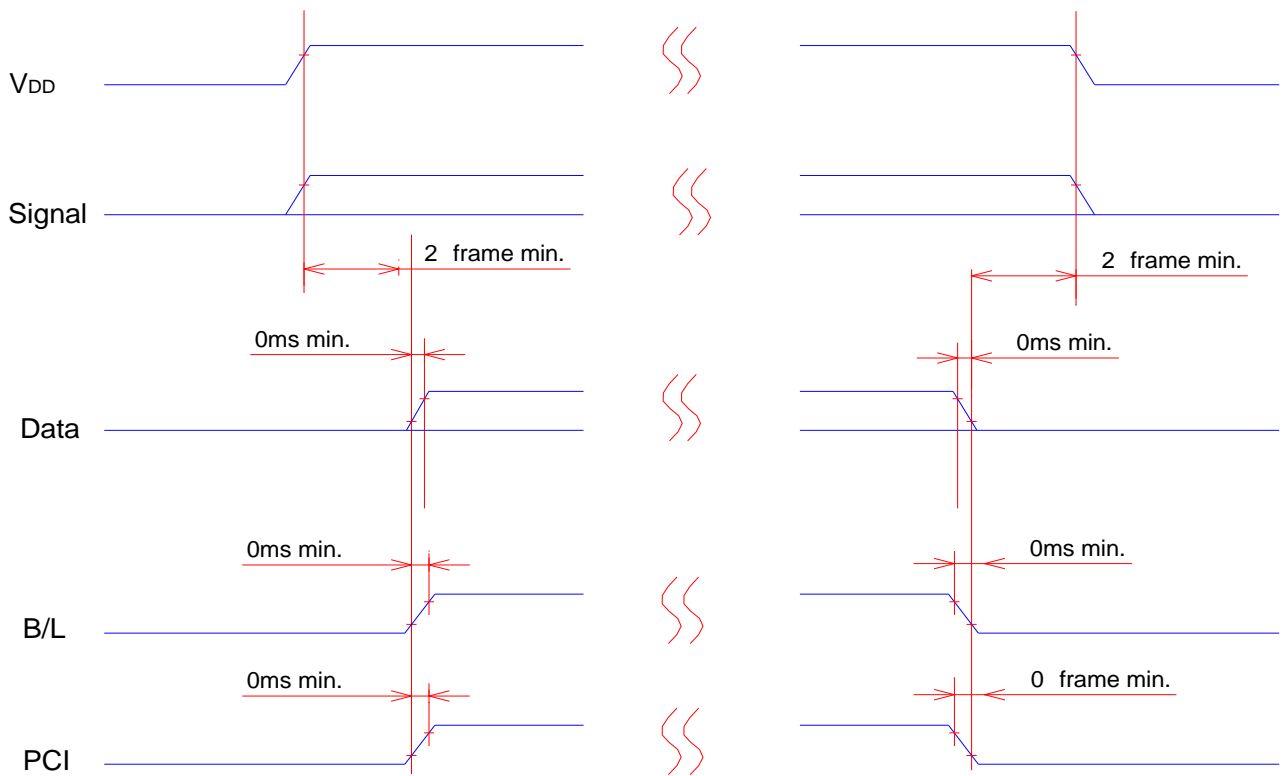

NOTE :

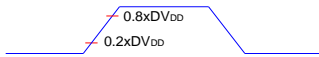

### 9.5 DATA INPUT for DISPLAY COLOR

Input color		Red Data						Green Data						Blue Data					
		R5	R4	R3	R2	R1	R0	G5	G4	G3	G2	G1	G0	B5	B4	B3	B2	B1	B0
		MSB			LSB			MSB			LSB			MSB			LSB		
Basic color	Black	0	0	0	0	0	0	0	0	0	0	0	0	0	0	0	0	0	0
	Red(63)	1	1	1	1	1	1	0	0	0	0	0	0	0	0	0	0	0	0
	Green(63)	0	0	0	0	0	0	1	1	1	1	1	1	0	0	0	0	0	0
	Blue(63)	0	0	0	0	0	0	0	0	0	0	0	0	1	1	1	1	1	1
	Cyan	0	0	0	0	0	0	1	1	1	1	1	1	1	1	1	1	1	1
	Magenta	1	1	1	1	1	1	0	0	0	0	0	0	1	1	1	1	1	1
	Yellow	1	1	1	1	1	1	1	1	1	1	1	1	0	0	0	0	0	0
	White	1	1	1	1	1	1	1	1	1	1	1	1	1	1	1	1	1	1
Red	Black	0	0	0	0	0	0	0	0	0	0	0	0	0	0	0	0	0	0
	Red (1)	0	0	0	0	0	1	0	0	0	0	0	0	0	0	0	0	0	0
	Red (2)	0	0	0	0	1	0	0	0	0	0	0	0	0	0	0	0	0	0
	:	:	:	:	:	:	:	:	:	:	:	:	:	:	:	:	:	:	:
	:	:	:	:	:	:	:	:	:	:	:	:	:	:	:	:	:	:	:
	Red (62)	1	1	1	1	1	0	0	0	0	0	0	0	0	0	0	0	0	0
	Red (63)	1	1	1	1	1	1	0	0	0	0	0	0	0	0	0	0	0	0
Green	Black	0	0	0	0	0	0	0	0	0	0	0	0	0	0	0	0	0	0
	Green (1)	0	0	0	0	0	0	0	0	0	0	0	1	0	0	0	0	0	0
	Green (2)	0	0	0	0	0	0	0	0	0	0	1	0	0	0	0	0	0	0
	:	:	:	:	:	:	:	:	:	:	:	:	:	:	:	:	:	:	:
	:	:	:	:	:	:	:	:	:	:	:	:	:	:	:	:	:	:	:
	Green (62)	0	0	0	0	0	0	1	1	1	1	1	0	0	0	0	0	0	0
	Green (63)	0	0	0	0	0	0	1	1	1	1	1	1	0	0	0	0	0	0
Blue	Black	0	0	0	0	0	0	0	0	0	0	0	0	0	0	0	0	0	0
	Blue (1)	0	0	0	0	0	0	0	0	0	0	0	0	0	0	0	0	0	1
	Blue (2)	0	0	0	0	0	0	0	0	0	0	0	0	0	0	0	0	1	0
	:	:	:	:	:	:	:	:	:	:	:	:	:	:	:	:	:	:	:
	:	:	:	:	:	:	:	:	:	:	:	:	:	:	:	:	:	:	:
	Blue (62)	0	0	0	0	0	0	0	0	0	0	0	0	1	1	1	1	1	0
	Blue (63)	0	0	0	0	0	0	0	0	0	0	0	0	1	1	1	1	1	1

## 9.6 DATA ADDRESS

D (0,0)      D (1,0)

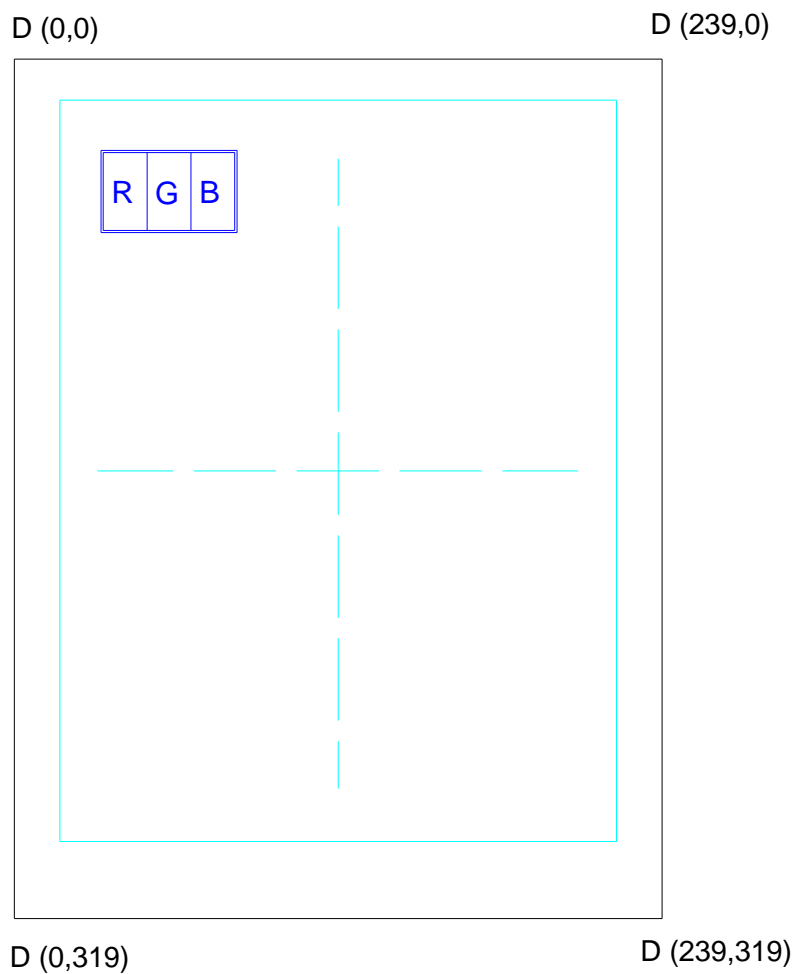

Top View



# 10. OUTLINE DIMENSIONS

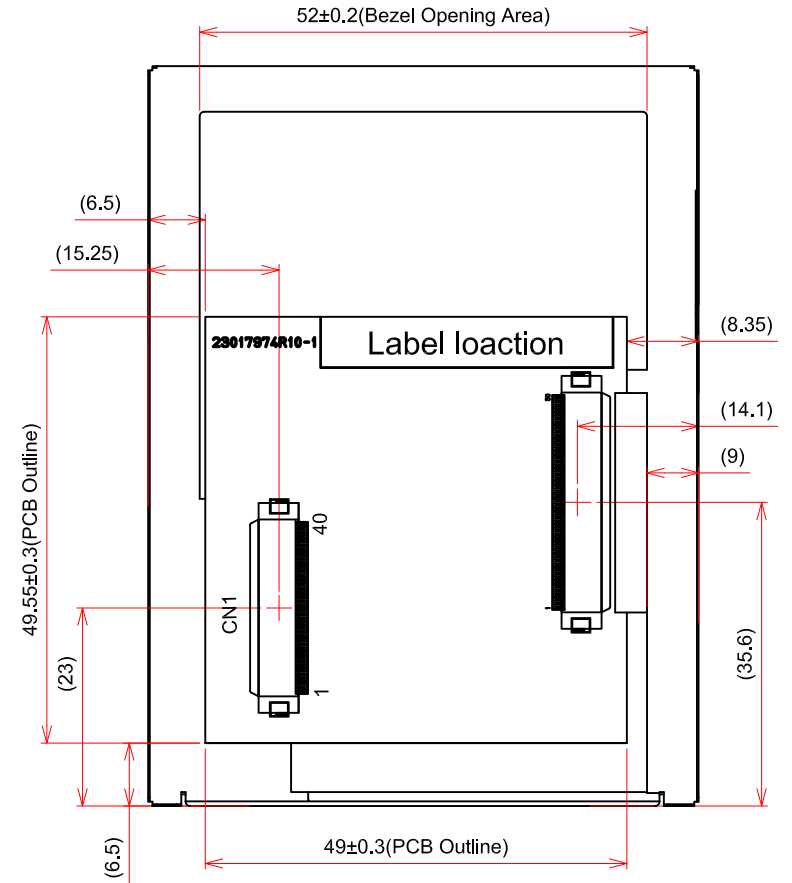
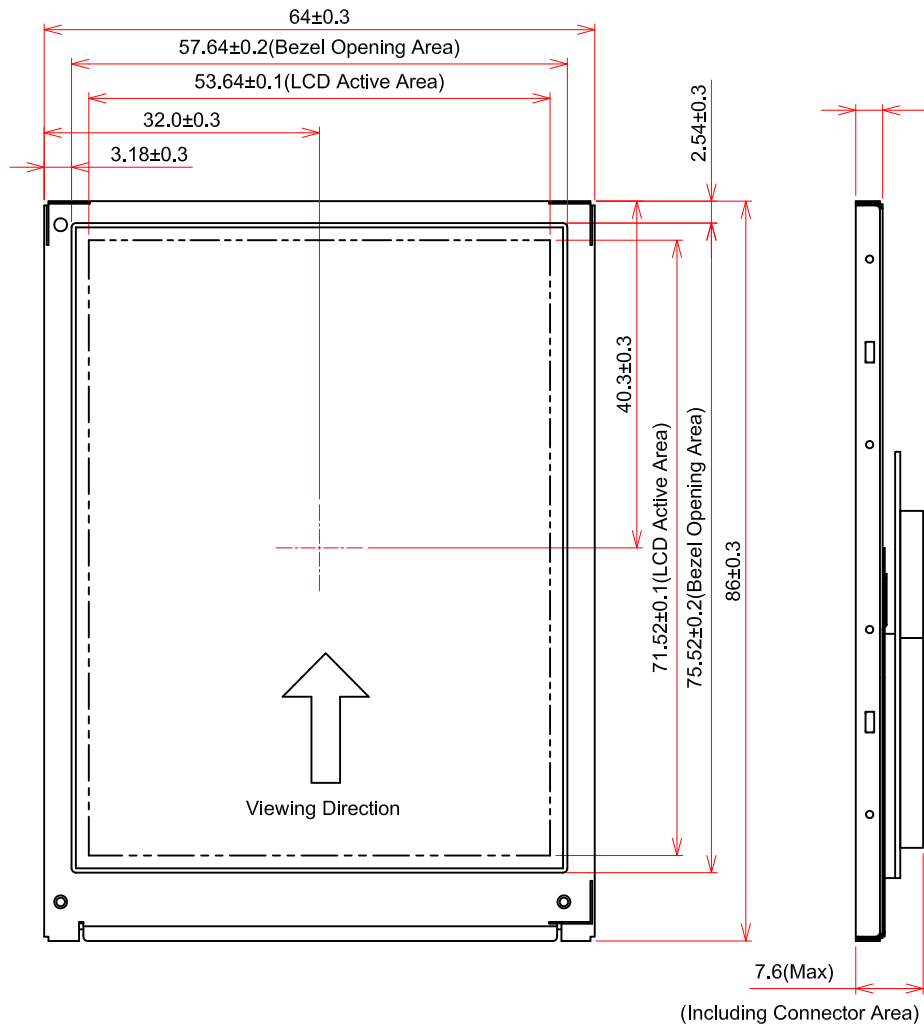

Scale : NTS  
Unit : mm

# 11. APPEARANCE STANDARD

The appearance inspection is performed in a room around 500~1000 lx based on the conditions as below:

- The distance between inspector's eyes and display is 30 cm.
- The viewing zone is defined with angle  $\theta$  shown in Fig.11.1 The inspection should be performed within  $45^\circ$  when display is shut down. The inspection should be performed within  $5^\circ$  when display is power on.

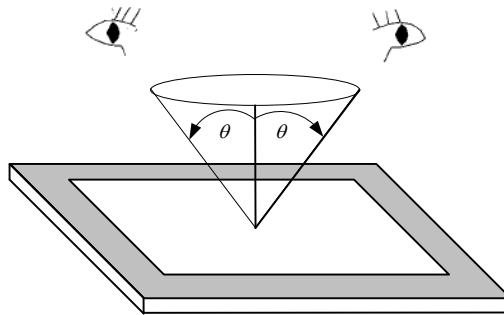

Fig. 11.1

## 11.1 THE DEFINITION OF LCD ZONE

LCD panel is divided into 2 areas as shown in Fig.11.2 for appearance specification in next section.

A zone is the LCD active area (dot area).

B zone is the area between A zone and metal frame.

In terms of housing design, B zone is the recommended window area customers' housing should be located in.

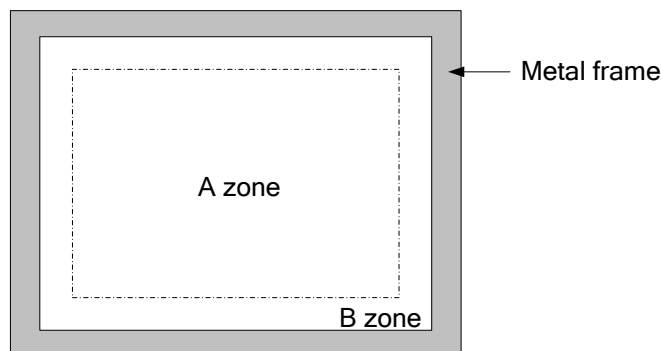

Fig. 11.2

## 11.2 LCD APPEARANCE SPECIFICATION

The specification as below is defined as the amount of unexpected phenomenon or material in different zones of LCD panel. The definitions of length, width and average diameter using in the table are shown in Fig.11.3 and Fig.11.4.

Item	Criteria			Applied zone
Scratches	Length / L(mm)	Width / W(mm)	Maximum number Acceptable	A,B
	$L \leq 2.0$	$W \leq 0.03$	Ignored	
	$L \leq 2.0$	$0.03 < W \leq 0.05$	4	
	$2.0 < L$	$0.05 < W$	None	
Dent	Serious one is not allowed.			A
Wrinkles in Polarizer	Serious one is not allowed.			A
Bubbles on Polarizer	Average diameter / D(mm)		Maximum number Acceptable	A
	$D \leq 0.3$		2	
	$0.3 < D$		None	
1) Stains 2) Foreign Materials 3) Dark Spot	Filamentous (Line shape)			A,B
	Length / L(mm)	Width / W(mm)	Maximum number Acceptable	
	$L < 2.0$	$W \leq 0.05$	4	
	$L \leq 1.0$	$0.05 < W \leq 0.1$	2	
	Round (Dot shape)			A,B
	Average diameter / D(mm)		Maximum number acceptable	
	$D \leq 0.15$		6	
	$0.15 < D \leq 0.2$		4	
	$0.2 < D$		None	
	In total		Filamentous + Round=9	
Those wiped out easily are acceptable.				
Dot-Defect (Note 1)	Type		Maximum number acceptable	A,B
	Sparkle mode	1 dot	4	
		2 dots	2(sets)	
		In total	4	
	Black mode	1 dot	4	
		2 dots	2(sets)	
		In total	4	
	Sparkle mode & Black mode	2 dots	2(sets)	
In total		6		

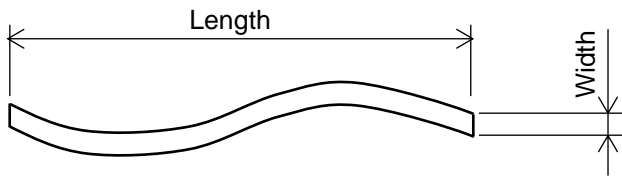
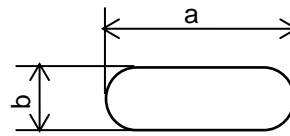

Fig.11.3



$$\text{Average diameter} = \frac{a+b}{2}$$

Fig.11.4

Note 1: The definitions of dot defect are as below:

- The defect area of the dot must be bigger than half of a dot.
- For bright dot-defect, showing black pattern, the dot's brightness must be over 30% brighter than others.
- For dark dot-defect, showing white pattern, the dot's brightness must be under 70% darker than others.
- The definition of 1-dot-defect is the defect-dot, which is isolated and no adjacent defect-dot.
- The definition of adjacent dot is shown as Fig. 11.5.

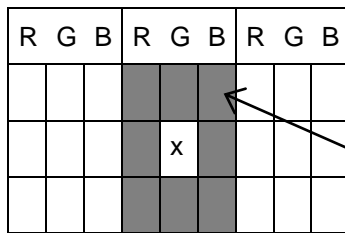

The dots colored in gray are adjacent to defect - dot "X".

Fig 11.5

## 12. PRECAUTIONS

### 12.1 PRECAUTIONS of ESD

- 1) Before handling the display, please ensure your body has been connected to ground to avoid any damages by ESD. Also, do not touch display's interface directly when assembling.
- 2) Please remove the protection film very slowly before turning on the display to avoid generating ESD.

### 12.2 PRECAUTIONS of HANDLING

- 1) In order to keep the appearance of display in good condition, please do not rub any surfaces of the displays by using sharp tools harder than 3H, especially touch panel, metal frame and polarizer.
- 2) Please do not stack the displays as this may damage the surface. In order to avoid any injuries, please avoid touching the edge of the glass or metal frame and wore gloves during handling.
- 3) Touching the polarizer or terminal pins with bare hand should be avoided to prevent staining and poor electrical contact.
- 4) Do not use any harmful chemicals such as acetone, toluene, and isopropyl alcohol to clean display's surfaces.
- 5) Please use soft cloth or absorbent cotton with ethanol to clean the display by gently wiping. Moreover, when wiping the display, please wipe it by horizontal or vertical direction instead of circling to prevent leaving scars on the display's surface, especially polarizer.
- 6) Please wipe any unknown liquids immediately such as saliva, water or dew on the display to avoid color fading or any permanent damages.
- 7) Maximum pressure to the surface of the display must be less than  $1.96 \times 10^4$  Pa. If the area of applied pressure is less than  $1 \text{ cm}^2$ , the maximum pressure must be less than 1.96N.

### 12.3 PRECAUTIONS OF OPERATING

- 1) Please input signals and voltages to the displays according to the values defined in the section of electrical characteristics to obtain the best performance. Any voltages over than absolute maximum rating will cause permanent damages to this display. Also, any timing of the signals out of this specification would cause unexpected performance.
- 2) When the display is operating at significant low temperature, the response time will be slower than it at  $25\text{C}^\circ$ . In high temperature, the color will be slightly dark and blue compared to original pattern. However, these are temperature-related phenomenon of LCD and it will not cause permanent damages to the display when used within the operating temperature.
- 3) The use of screen saver or sleep mode is recommended when static images are likely for long periods of time. This is to avoid the possibility of image sticking.
- 4) Spike noise can cause malfunction of the circuit. The recommended limitation of spike noise is no bigger than  $\pm 100 \text{ mV}$ .

## 12.4 PRECAUTIONS of STORAGE

If the displays are going to be stored for years, please be aware the following notices.

- 1) Please store the displays in a dark room to avoid any damages from sunlight and other sources of UV light.
- 2) The recommended long term storage temperature is between 10 C° ~35 C° and 55%~75% humidity to avoid causing bubbles between polarizer and LCD glasses, and polarizer peeling from LCD glasses.
- 3) It would be better to keep the displays in the container, which is shipped from JDI, and do not unpack it.
- 4) Please do not stick any labels on the display surface for a long time, especially on the polarizer.

### 13. DESIGNATION of LOT MARK

1) The lot mark is showing in Fig.13.1. First 4 digits are used to represent production lot, T represented made in Taiwan, and the last 6 digits are the serial number.

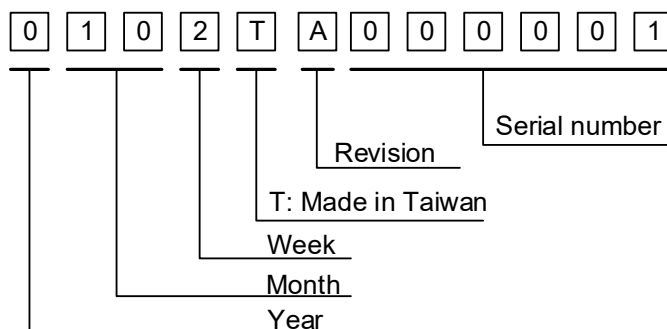

Fig. 13.1

2) The tables as below are showing what the first 4 digits of lot mark are shorted for.

Year	Lot Mark
2020	0
2021	1
2022	2
2023	3
2024	4

Month	Lot Mark	Month	Lot Mark
Jan.	01	Jul.	07
Feb.	02	Aug.	08
Mar.	03	Sep.	09
Apr.	04	Oct.	10
May	05	Nov.	11
Jun.	06	Dec.	12

Week	Lot Mark
1~7 days	1
8~14 days	2
15~21 days	3
22~28 days	4
29~31 days	5

3) Except letters I and O, revision number will be shown on lot mark and following letters A to Z.

REV. No	Item	Remarks
A	-	-
B	Color filter changed	PCN 1028
B	Connector (CN1) changed	PCN 1097

4) The location of the lot mark is on the PCB shown in Fig. 13.2.

Label example:



Fig. 13.2